

# **User Manual**

**IP Camera**

**Model No.: GD 2807**

Please read this user manual carefully before operation and keep it properly for future reference.



# Contents

1、 Product Overview	1
2、 Product Features	1
3、 Packing List	2
4、 Structure	3
5、 Installation Mode	4
6、 Product Specifications	6
7、 Software Operation	7
8、 Appendixes	33

# 1、Product Overview

GD2807 is an integrated IP Camera solution. It adopts a single highly integrated chip SOC to implement media processing with the integration of video acquisition, compression and network transmission in a card, which provides an extremely high definition, highly integrated and low cost solution for LAN/WAN-based remote video monitoring devices. It is a kind of digital IP Camera product. This IP Camera solution is applicable to small & medium homes or business offices, as well as various occasions needing the application of remote network video transmission and monitoring. The product features easy installation and simple operation.

## 2、Product Features

- ◆ Powerful high-performance programmable media processor and high-speed video protocol processor
- ◆ Supporting various high-sensitivity CCD or CMOS sensors (SONY, SHARP, and so on), and supporting both analog and digital video input interfaces
- ◆ Adopting optimized H.264 video compression algorithm to easily implement low-bandwidth network transmission of high-definition images
- ◆ Supporting simultaneous browsing of a maximum of 10 users
- ◆ Embedded Web Server to facilitate users to implement real-time front-end monitoring and setting management by a standard IE
- ◆ Supporting wireless network (Wi-Fi/802.11b/g), mobile networks (CDMA1X and GPRS), and monitoring by mobile phones
- ◆ Providing an SD card slot to facilitate local image storage
- ◆ Supporting remote system upgrade
- ◆ Supporting dynamic domain name resolution, as well as LAN and Internet (ADSL, Cable Modem)
- ◆ Supporting multiple network protocols: HTTP、TCP/IP、UDP、STMP、DDNS、DNS、SNTP、DHCP、FTP

- ◆ Remote Pan/Tilt rotate(Horizontal:270deg/Vertical:120deg)
- ◆ Network adaptation technology, supporting automatic video frame rate adjustment according to the network bandwidth
- ◆ Giving alarm in case of video loss or motion detection (settable defense zone and sensitivity)
- ◆ Various embedded high-speed-dome and decoder protocols, supporting transparent transmission protocols
- ◆ Supporting image shielding/image snapshot
- ◆ Automatic fault recovery and automatic connection after network interruption

### 3、 Packing List

- ① IP Camera × 1
- ② Network Cable × 1
- ③ CD × 1
- ④ 9V/1.5A Power Adapter × 1
- ⑤ Wi-Fi Antenna × 1
- ⑥ Bracket(Optional) × 1
- ⑦ Metal Screws for Bracket  
(Optional) × 4



## 4、 Structure

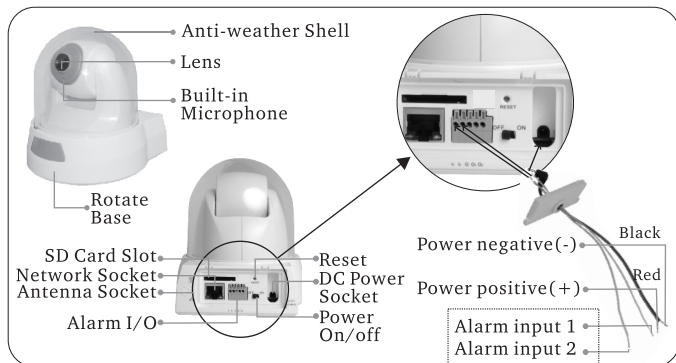

### Description of rear panel connection:

 : Ethernet interface

 : SD memory card slot

**OFF/ON:** Power switch (ON: turns on; OFF: turns off)

**DC9V:** Power input, DC 9V/1.5A

 : Parameter reset button. Press this button to reset to factory default settings.  
Use this button only when necessary

**Alarm I/O:** Two lines for alarm in, two lines for alarm out.  
The function can not be realized for the moment.

## 5. Installation Mode

### 5-1 Installation Precautions

**Note:** Before installing and using the product, please read the following precautions carefully and make sure they are fully understood.

- \* Use only the power adapter attached with the product. Use of unauthorized power adapter may cause damage to your IP Camera.
- \* Do not touch the lens of the IP Camera for it may leave fingerprint or stain on the lens and will cause vague or unclear images.
- \* Do not turn the lens of the IP Camera at will. The optimum focus range has been set before the IP Camera is delivered out of the factory. If you turn the lens, it may cause incorrect focus and vague images.
- \* IP Camera terminal shall be installed in an indoor environment.
- \* For firmware upgrading or connection with an external alarm, refer to detailed instructions contained in the CD.
- \* Do not turn the Pan/Tilt by force , it may cause damage to internal component of the Pan/Tilt.

### 5-2 Installation Modes

IP Camera has two installation modes.

#### 5-2-1 Horizontal installation

Select a position on a horizontal surface and place the IP Camera directly on the horizontal surface. Connect the Wi-Fi antenna to the antenna interface on the rear of the IP Camera.

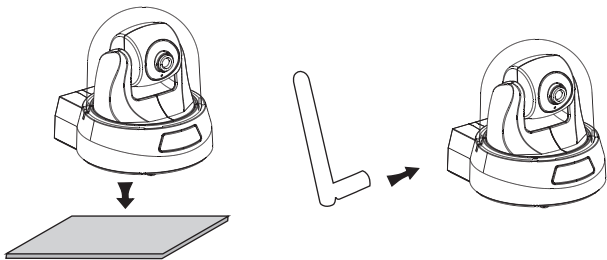

### 5-2-2 Suspended installation

Use the bracket included in the package to install the camera on the wall or under the ceiling.

There is one special rivet on bracket to locate the camera in the center, and 4 rivets holes on each side to root the bracket on wall or under ceiling.

1. Install the bracket to proper position on the wall, or settled upside down under the ceiling.
2. Root the special screw to the 1/4" screw hole on the bottom of camera.

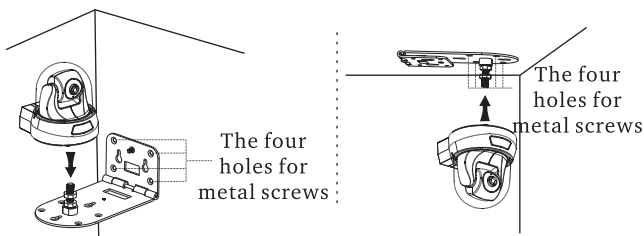

### 5-3 Hardware Installation

For details, refer to *Quick Installation Guide*.

## 5-3 Software Installation

For details, refer to *Quick Installation Guide*.

## 6. Product Specifications

Item	Parameter
Video input	Supporting NTSC/PAL system
Video compression	H.264 baseline profile@Level 2.2
Video resolution	PAL: 320*240 (QVGA) , 640*480 (VGA) NTSC: 320*240 (QVGA) , 640*480 (VGA)
Video parameter adjustment	Brightness, chrominance, contrast, saturation, and image quality
CMOS parameter adjustment	Automatic White Balance (AWB), Automatic Gain Control (AGC), Backlight Compensation (BLC), Automatic Light Control /Electronic Light Control (ALC/ELC)
Stream format	Pure video stream or composite video & audio stream
Video frame rate	PAL: 1~25 frame/second; NTSC: 1~30 frame/second;
Video compression code rate	16Kbit/S ~ 2Mbit/S
Communication interface	One 10M/100M adaptive Ethernet interface
Rotate Angle	Horizontal:270°;Vertical:120°
Input power	DC 9V 1.5A
Maximum power	Less than 6W
Operating temperature	0 ~ +40°C
Operating humidity	10 ~ 85%
System requirement	Operating system: Microsoft Windows 98/2000/ME/NT 5.0/XP/Vista. Browser: Microsoft Internet Explorer 6.0 or later version
Wi-Fi module	Supporting IEEE802.11b/g wireless network
Dimensions(W×D×H)	116×140×129mm
Weight (approx.)	345g

## 7、 Software Operation

Enter the IP address of the IP Camera in the address bar of the Internet Explorer (IE), for example, the default address <http://192.168.1.1> or a modified IP address by search (for example, <http://192.168.91.1>), to log on to the IP Camera. Enter the user name (default user name: **admin**) and password (default password: **admin**), and click <**OK**> to enter the main interface, as shown below:

No function



### 7-1 Parameter Settings for IP Camera

**Note:** Only a system administrator can log on to the parameter setting interface of the IP Camera.

#### 7-1-1 System Setting of IP Camera

1. Click <**System**>, and the IP Camera parameter setting

interface appears, as shown in the following figure:

The screenshot displays the 'Real-time IP-CAM Monitoring System' interface. On the left is a navigation menu with icons and labels for LiveView, System, Video, Motion, Network, Advanced, User Manage, Image Set, and SD Card. Below the menu is a directional pad and three buttons labeled H, S, and V. The main content area is titled 'System' and contains several sections: 'Time Sync' with a 'Time Sync' button; 'NTP Parameters' with an 'Enable NTP' checkbox, a 'Time zone' dropdown menu set to '(GMT+08:00) Beijing, Hongkong, Singapore, Taipei', and an 'NTP server' text field containing 'clock.isc.org' with a 'Save' button; 'System Information' with an 'IP Camera name' dropdown set to 'CAMERA' and an 'ID' text field containing '1001' with a 'Save' button; 'Upgrade' with a 'Type' dropdown menu showing 'Other (\*.uot)', 'Application (\*.uke)', and 'OCX (\*.uoc)', and a 'Version' dropdown menu showing 'Other (\*.uot)', with an 'Upgrade' button; 'Storage parameter' with 'Record file path' and 'Capture file path' text fields both containing 'C:\XDNVSY\'; and 'System Operation' with 'Restore Default' and 'Reboot' buttons.

The interface for setting **System** parameters of the IP Camera is shown in the above figure. You may set the time, name, upgrade page, and capturing/recording path of the IP Camera.

**[Time Sync]**: Click the button to synchronize the time with PC (set to the default value when being delivered out of factory).

**[Enable NTP]**: Click to enable the NTP setting switch.

**[Time Zone]**: Select the right time zone in the drop-down list box on the right.

**[NTP server]**: Enter the IP address or http address of the time server, for example, clock.isc.org.

**[Upgrade]**: The user can upgrade the software version by updating the kernel file (\*.uke) and the control file (\*.uoc). Click **<Browse>**, select a correct upgrade file, and click **<Upgrade>** to start upgrade. After the completion of upgrade, the system will prompt the successful upgrade, and the IP Camera will automatically reboot. Detailed operations are as follows:

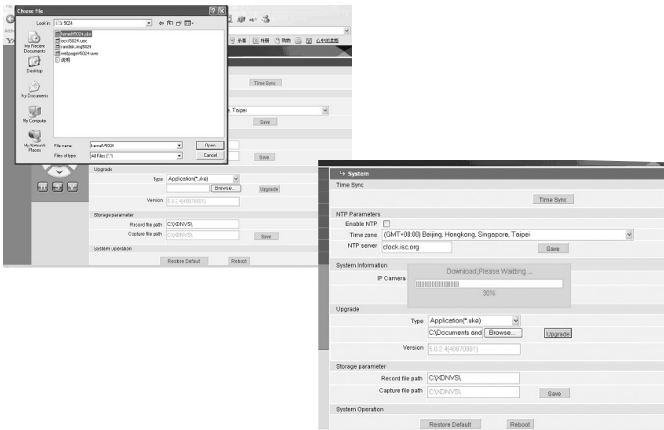

For example: The currently operated device is an IP Camera, with the version as shown in the above figure (5.0.0.6). Get the latest version of the IP Camera from the manufacturer (file name: **auto1D1\_V5007**; version: 5.0.0.7), and then click **<Browse>**. Select the file **auto1D1\_V5007**, click **<Upgrade>**, and it starts to download the file to the IP Camera. After the completion of the download, the IP Camera will write the file into its FLASH chip. During this process, it will show the upgraded percentage. After the completion of upgrade, the system will prompt the successful upgrade, and the IP Camera will automatically reboot. Log on again to enter the setting interface and check whether the version number matches the upgraded one.

**Note:** During the upgrade, make sure that the power and network connection of the IP Camera are not interrupted.

**[Storage parameter]:** Used to set the harddisk position for storing recorded files and captured images.

**[Record file path]:** Set the directory for storing recording files and images, and default path is **C:\XDNVS**.

**[Capture file path]:** Set the directory for storing captured

images, and the default path is **C:\XDNVS**.

**[Restore Default]:** Used to restore all parameters of the IP Camera (including network parameters, excluding physical address) to their default settings.

**Note:** Please use this function prudently!

**[Reboot]:** Used to reboot the IP Camera. The IP Camera will reboot in about five seconds.

## 7-1-2 Video **Setting Video Parameters of IP Camera**

The interface for setting the **Video** parameters of the IP Camera is as follows:

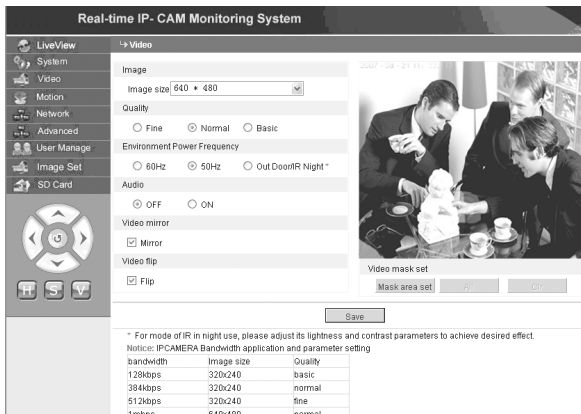

The screenshot shows the 'Real-time IP-CAM Monitoring System' interface. On the left is a navigation menu with options: LiveView, System, Video, Motion, Network, Advanced, User Manage, Image Set, and SD Card. The 'Video' option is selected. The main panel displays various video settings:

- Image:** Image size is set to 640 \* 480.
- Quality:** Radio buttons for Fine, Normal (selected), and Basic.
- Environment Power Frequency:** Radio buttons for 60Hz, 50Hz (selected), and Out Door/IR Night\*.
- Audio:** Radio buttons for OFF (selected) and ON.
- Video mirror:** A checked checkbox for Mirror.
- Video flip:** A checked checkbox for Flip.

On the right, there is a live video feed showing three people at a table. Below the feed is a 'Video mask set' section with a 'Mask area set' label and two buttons labeled 'PT' and 'GT'. A 'Save' button is located at the bottom center of the settings panel.

\* For mode of IR in night use, please adjust its lightness and contrast parameters to achieve desired effect.

Notice: IPCAMERA Bandwidth application and parameter setting

bandwidth	Image size	Quality
128kbps	320x240	basic
384kbps	320x240	normal
512kbps	320x240	fine
1mbps	640x480	normal

**[Image size]:** Used to set the resolution of images. You may select a resolution of coding formats VGA (640\*480) and QVGA (320\*240).

**Note:** It will take about 15 seconds to change the resolution. The following figure shows an image in the QVGA (320\*240) format:



**[Quality]:** Used to select image quality. Fine is selected by default.

**Note:** To achieve an ideal effect on the network, it is necessary to set the above two parameters reasonably. The following are recommended settings:

Bandwidth	Image Size	Quality
128kbps	320×240	basic
384kbps	320×240	normal
512kbps	320×240	fine
1mbps	640×480	normal
2mbps	640×480	fine

**[Environment Power Frequency]:** Used to select the power frequency of the operating environment. Incorrect selection may cause image blinking. Select 50 Hz in China and select 60 Hz in the U.S.

**[Mirror]:** Image mirror switch.

**[Flip]:** Image flip switch.

**[Video mask set]:** Set the image mask area.

**[Area set]:** Click the left mouse button and drag the mouse to delimit the masking area.

**[Clr]:** Used to clear the set masking area.

**[All]:** Indicates the entire video area is the masking area.

After the parameters are set, click **<Save>**, and the settings take effect.

### 7-1-3 Motion **Motion Detection Settings of IP Camera**

The interface for setting the **Motion** parameters of the IP Camera is as follows:

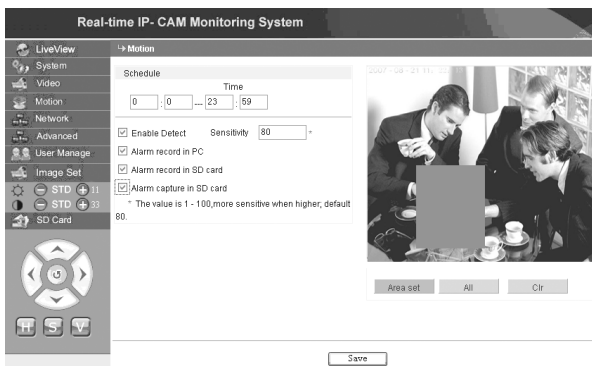

Motion detection area (the image is divided into 22 \* 18 blocks. Double click a block to be set, and set or cancel the motion detection settings, or select a block with the mouse), alarm detection time, alarm detection switch, and motion alarm detection sensitivity. After the parameters are set, click **<Save>**, and the settings take effect.

**[Area set]:** Click and drag the mouse to delimit the detection area. To select multiple areas, press the <Ctrl> key while selecting an area. Selected areas will be highlighted in red.

**[Clr]:** Used to clear the set motion detection area.

**[All]:** Indicates the entire video area is the motion detection area.

**[Time]:** Set different time periods for motion detection, for example, from 00:00 to 23:59 in each day.

**[Enable Detect]:** If the check box is selected, dynamic detection and alarm is allowed in the range of the set detection sensitivity. The value range of sensitivity is 1 ~ 100. The greater the value is, the higher the sensitivity will be. The default value is 80.

**[Alarm record in PC]:** If the check box is selected, the video in motion detection alarm will be recorded and stored in a PC. The recording time for each alarm is about 30 seconds. When the system detects a dynamic alarm, the alarm on the interface will blink, and the left column will give a prompt of alarm time, as shown below:



**Note:** If **[Alarm record in PC]** is not selected, motion alarm will be also recorded to the SD card automatically.

## 7-1-4 **Setting Advanced Parameters of IP Camera**

The interface for setting the **Advanced** parameters of the IP Camera is as follows:

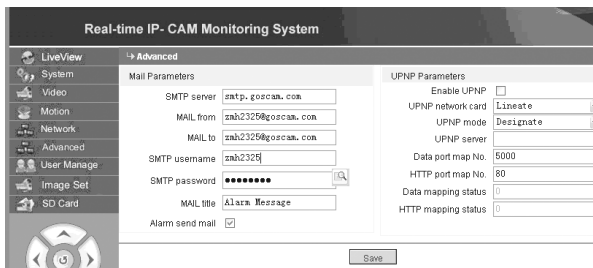

Real-time IP-CAM Monitoring System	
<b>LiveView</b>	<b>Advanced</b>
System	Mail Parameters
Video	SMTP server: <input type="text" value="smtp.gozcam.com"/>
Motion	MAIL from: <input type="text" value="znh2325@gozcam.com"/>
Network	MAIL to: <input type="text" value="znh2325@gozcam.com"/>
Advanced	SMTP username: <input type="text" value="znh2325"/>
User Manage	SMTP password: <input type="password" value="••••••"/>
Image Set	MAIL title: <input type="text" value="Alarm Message"/>
SD Card	Alarm send mail: <input checked="" type="checkbox"/>
	UPNP Parameters
	Enable UPNP: <input type="checkbox"/>
	UPNP network card: <input type="text" value="Lineate"/>
	UPNP mode: <input type="text" value="Designate"/>
	UPNP server: <input type="text"/>
	Data port map No.: <input type="text" value="5000"/>
	HTTP port map No.: <input type="text" value="80"/>
	Data mapping status: <input type="text" value="0"/>
	HTTP mapping status: <input type="text" value="0"/>
	<input type="button" value="Save"/>

### **E-mail function triggered by IP Camera alarm**

Settings related to the sending of e-mails depend on whether the motion detection alarm settings are enabled. If an alarm is triggered by an event, the system will send the alarm to a designated e-mail box.

#### **Operation procedures:**

- Step 1: **[SMTP server]**: Fill in the name and address of the mail server of the sender, for example, SMTP.gozcam.com.
- Step 2: **[MAIL from]**: Fill in the e-mail address of the sender;
- Step 3: **[MAIL to]**: Fill in the e-mail address of the recipient;
- Step 4: **[SMTP username]**: Fill in the user name used to log on to the e-mail box of the sender;
- Step 5: **[SMTP password]**: Fill in the password used to log on to the e-mail box of the sender;
- Step 6: **[MAIL title]**: Fill in the title of the e-mail message to be sent;
- Step 7: **[Alarm send mail]**: Select the check box to enable the function;

Step 8: Click <**Save**> to complete the setting.

**Note:** To invalidate the settings upon completion, it is necessary to reboot the IP Camera and the alarm.

### **UPNP settings of IP Camera**

The UPNP can automatically map the data port and Web port to the router according to the settings. An extranet can access the Intranet via the mapped ports.

Step 1: [**Enable UPNP**]: Click to turn on the UPNP setting switch;

Step 2: [**UPNP network card**]: Select the type of network card from the drop-down menu;

Step 3: [**UPNP mode**]: Select mapped port and mode in the drop-down menu;

Step 4: [**UPNP server**]: Fill in the IP address of the router gateway which supports UPNP;

Step 5: [**Data port map NO.**]: Fill in the port number of the data port after it is mapped to the extranet. If no Internet IP address is available when the Intranet is used, it is necessary to use port mapping. By default, the data mapping port is 5000;

Step 6: [**HTTP port map NO.**]: Fill in the port number of the Web port after it is mapped to the extranet. If no Internet IP address is available when the Intranet is used, it is necessary to use port mapping. By default, the Web mapping port is 80;

Step 7: Click <**Save**> to complete the setting.

## **7-1-5 Setting Network Parameters of IP Camera**

At present, different Internet access methods can be used. The network settings of the IP Camera vary with different Internet access modes of users.

### **7-1-5-1 Setting network parameters of local IP Camera**

The interface for setting the **Network** parameters of the IP Camera is as follows:

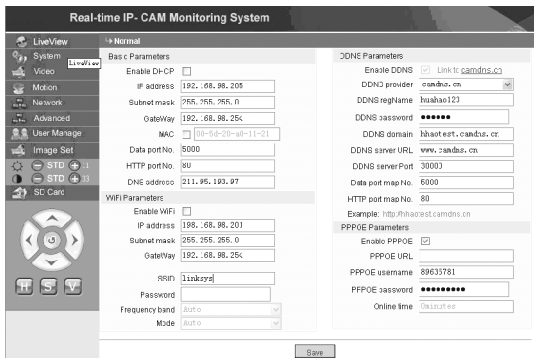

Where, the user can set parameters related to IP address, Wi-Fi, dynamic domain name, and PPPoE of the IP Camera. Detailed settings are described as follows.

## 7-1-5-2 Accessing a IP Camera from the Internet

When you set the IP Camera on a LAN and have to access the IP Camera from the outside of the LAN, it is necessary to perform cross-gateway settings for your IP Camera. To make access easier, the user can set the DDNS.

### 1. Cross-gateway setting

Settings of a gateway are rather complicated. It is recommended to turn to a professional for help. This user manual only gives a brief introduction. As shown in the figure below, suppose one or more PCs and IP Cameras are connected to Intranet port of the same router (IP sharer).

The user can modify the settings of the router by either of the following ways to enable a remote PC on the extranet to access the IP Camera.

\* Setting virtual server gateway

Take the WRT54G router of LINKSYS for example,  
(1) Obtain the IP address of the router (LAN gateway address), user name and password for logon to the router from the network administrator.

(2) Enter the LAN IP address of the router in the address bar of the IE to log on to the router; Enter user name and password to open the setting page of the router, as shown below:



(3) Select “Applications & Gaming” Port Range Forward .

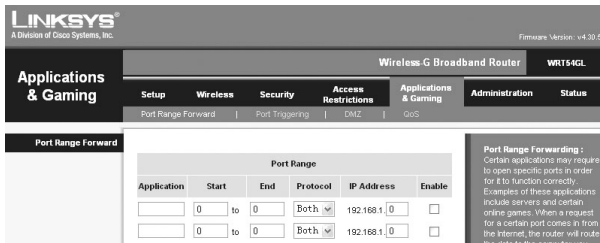

(4) Enter the application name (for example, ipcam01) of the IP Camera in the **Application** box.

Enter server port number 80 in the **Start** and **End** frames;  
Select **Both** in the **Protocol** box;

Enter the IP address of the IP Camera in the Intranet in the **IP Address** box, for example, 192.168.1.1; Select the **Enable** check

Box.

In addition, we have to perform port mapping for video stream data port 5000 of the IP Camera. The setting method is the same as above, as shown below:

The screenshot shows the Linksys WRT54GL router configuration interface. The 'Applications & Gaming' tab is selected, and the 'Port Range Forward' sub-tab is active. A table titled 'Port Range' contains the following entries:

Application	Start	End	Protocol	IP Address	Enable
ipcam01	80	80	Both	192.168.1.1	<input checked="" type="checkbox"/>
ipcam01	5000	5000	Both	192.168.1.1	<input checked="" type="checkbox"/>

To the right of the table is a 'Port Range Forwarding' help box with the following text:

**Port Range Forwarding :**  
Certain applications may require to open specific ports in order for it to function correctly. Examples of these applications include servers and certain online games. When a request for a certain port comes in from the Internet, the router will route the data to the computer you

(5) Click **<Save>** to save the settings.

Up to now, the forward rules corresponding to the server ports 80 and 5000 have been set.

(6) Obtain the WAN address of the router.

The user can find the WAN address of the router from the operation status of the router. In this example, the address is 192.168.91.101.

The screenshot shows the Linksys WRT54GL router configuration interface. The 'Status' tab is selected, and the 'Router Information' sub-tab is active. The 'Router Information' section displays the following details:

- Firmware Version: v4.30.5, Apr. 27, 2006
- Current Time: Sun, 02 Sep 2007 20:27:13
- MAC Address: 00:90:4C:60:00:2B
- Router Name: WRT54GL
- Host Name:
- Domain Name:

The 'Internet' sub-tab is also visible, showing the following configuration:

- Configuration Type
- Login Type: Static
- IP Address: 192.168.91.101
- Subnet Mask: 255.255.255.0

To the right of the 'Router Information' section is a 'Firmware Version' help box with the following text:

**Firmware Version.** This is the Router's current firmware.  
**Current Time.** This shows the time, as you set on the Setup Tab.  
**MAC Address.** This is the Router's MAC Address, as seen by your ISP.  
**Router Name.** This is the specific name for the Router, which you set on the Setup Tab.  
**More...**  
**Configuration Type.** This shows the configuration type.

Up to now, the setting of router parameters is completed. If the router has a fixed WAN address, the user can access the IP Camera from the Internet. Enter [Http://192.168.91.101](http://192.168.91.101) in the address bar of the IE to access the IP Camera.

If several IP Cameras are connected to the same router, it is necessary to enter WAN address + port number in the IE to access different IP Cameras, for example, [Http://192.168.91.101:81](http://192.168.91.101:81) or [Http://192.168.91.101:800](http://192.168.91.101:800).

Video	Enable DHCP	<input type="checkbox"/>	Enable DDNS	<input type="checkbox"/> <a href="http://Link to 3322.org">Link to 3322.org</a>
Motion	IP address	<input type="text" value="192.168.1.1"/>	DDNS provider	<input type="text"/>
Network	Subnet mask	<input type="text" value="255.255.255.0"/>	DDNS regName	<input type="text" value="gozcan003"/>
Advanced	GateWay	<input type="text" value="192.168.1.254"/>	DDNS password	<input type="text" value="*****"/>
User Manage	MAC	<input type="checkbox"/> <input type="text" value="00-5d-20-a0-11-11"/>	DDNS server URL	<input type="text"/>
Image Set	Data port No.	<input type="text" value="5000"/>	DDNS server Port	<input type="text" value="30000"/>
SD Card	HTTP port No.	<input type="text" value="81"/>	Data port map No.	<input type="text" value="5000"/>

### \* Setting “DMZ host” gateway

The other method is to use the "DMZ host" function of a router. DMZ host enables a router to disable the firewall function for the IP address of a specific LAN so that the IP address is directly mapped to the external IP of the router. The DMZ host method supports only one internal IP Camera, no matter how many ports there are. For example, we can set the IP Camera with the IP address of 192.168.1.1 as the DMZ host. In the Internet, we can directly access the IP address [Http://192.168.1.1](http://192.168.1.1) of the router to access the IP Camera, as shown in the figure below:

The screenshot shows the Linksys WRT54GL router's web interface. The 'Applications & Gaming' tab is selected, and the 'DMZ' sub-tab is active. The 'DMZ' section has 'Enable' selected with a radio button, and the 'DMZ Host IP Address' is set to 192.168.1.1. There are 'Save Settings' and 'Cancel Changes' buttons at the bottom. A warning message on the right states: 'DMZ: Enabling this option will expose your router to the Internet. All ports will be accessible from the Internet. More...'

**Note:** The “virtual server” gateway and “DMZ host” gateway cannot be used at the same time.

## 2、Dynamic domain name resolution

Dynamic Domain Name System (DDNS) can map the dynamic IP address of an IP Camera to a fixed domain name. Therefore, we can access the IP Camera by the fixed domain name whether the IP address changes or not.

(1) Apply for DDNS domain name

Log on to the DDNS server: [www.camdns.cn](http://www.camdns.cn)



If you do not register, select **Register**. Enter camera ID, user name, password, DDNS domain name, and E-mail address, and click <**SUBMIT**>.



产品序号 Serial Number

用户名 User Name

登录密码 Login Password

重复输入密码 Verify Login Password

DDNS域名 DDNS Domain Name  
  
.camdns.cn

电子邮件 E-mail

If the registration succeeds, the following congratulation message appears. Remember your DDNS domain name.



**恭喜您成功注册了DDNS 域名：  
Congratulations!! you have sign  
up the new DDNS URL.**

用户名(Username): goscaml005

序列号(Serial Number): 1500780

动态域名 (DDNS Register Name):  
<http://goscaml005.camdns.cn>

请牢记您的密码，以便下次登录。

If you have registered your data, click **Member Login** directly. Enter user name and password and click <**Continue**>, as shown in the figure below.



After logon, you can view your registration information.



The user can edit the registration information, and then click <EDIT>. The following information appears:

	<b>無線網絡攝像機</b> <b>Network/IP Camera</b>
<a href="#">Register 用戶註冊</a>	<p><b>恭喜您成功修改了DDNS 域名：</b>  <b>Congratulations!! you have sign up the new DDNS URL.</b></p> <p>用户名(Username): goscam005</p> <p>序列号(Serial Number): 1500780</p> <p>电子邮件(E-mail): xxx@goscam.com</p> <p>动态域名 (DDNS Register Name): <a href="http://goscam005.camdns.cn">http://goscam005.camdns.cn</a></p> <p>请牢记您的密码，以便下次登录。</p> <p><a href="#">[返回 RETURN]</a></p>
<a href="#">Member Login 用戶登錄</a>	
<a href="#">Mobile Phone 手机监控</a>	
<a href="#">Support 服务支持</a>	
<a href="#">About CAMDNS 关于CAMDNS</a>	

## (2) Set DDNS server information for IP Camera

Then, please access your IP Camera in the address bar of DDNS dynamic domain . Setting in "network set" shown below :

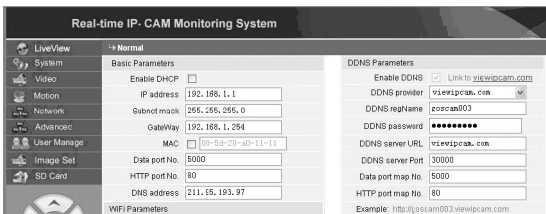

**Real-time IP-CAM Monitoring System**

LiveView → Normal

Basic Parameters	DDNS Parameters
Enable DHCP <input type="checkbox"/>	Enable DDNS <input checked="" type="checkbox"/> <a href="#">Link to viewipcam.com</a>
IP address: 192.168.1.1	DDNS provider: viewipcam.com
Subnet mask: 255.255.255.0	DDNS regName: goscam003
GateWay: 192.168.1.254	DDNS password: *****
MAC: 08-5d-20-a0-11-11	DDNS server URL: viewipcam.com
Data port No: 5000	DDNS server Port: 30800
HTTP port No: 80	Data port map No: 5080
DNS address: 211.55.193.97	HTTP port map No: 80
WiFi Parameters	Example: http://goscam003.viewipcam.com

Please select **DDNS provider**, for example, **viewipcam.com**. Enter the DDNS logon name and logon password, for example, **goscamm003**, and adopt default values for other parameters. Click **<Apply>** and the IP Camera will reboot. After re-connection, you will view that the “current operation status” changes to “updating IP address and DDNS server successfully”. It indicates the DDNS setting succeeds.

**Note:** To use this function, the LAN must have an open UDP port. If you have any question, please contact your network administrator or customer service center of the IP Camera provider for technical support.

If the gateway settings and DDNS settings have been completed, enter the DDNS dynamic domain name (for example, [Http://goscamm003.viewipcam.com](http://goscamm003.viewipcam.com), do not add www.) in the address bar of the IE to access the IP Camera. If multiple IP Cameras are connected to the same router, enter DDNS dynamic domain + port number (for example, [Http://goscamm003.viewipcam.com:81](http://goscamm003.viewipcam.com:81)) in the address bar of the IE to access different IP Cameras.

## **7-1-5-3 Use in ADSL environment**

### **1. Setting IP Camera**

Firstly, make sure the IP Camera is connected to the LAN or directly to a PC through a network cable, and enter the IP address of the IP Camera in the address bar of the IE. To enable the IP Camera to dial the ADSL number directly, it is necessary to set ADSL dial-up account and password. Before that, you need to enable the PPPoE function of the IP Camera. Enter the **Network** setting page of the IP Camera to enable the PPPoE service. Enter the logon name and password of the ADSL account into the figure shown below:

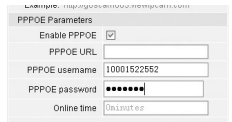

Then, click **<OK>** to reboot the system.

After the rebooting of the system, disconnect the power supply and network cable of the IP Camera and then reconnect them. Then, turn on the power and reboot the IP Camera again. The user has to wait until the ADSL link established (the process will take about 1 to 2 minutes)..

## 2.Connecting with ADSL Modem for Internet access

(1) Using a router to access the Internet by shared ADSL If a router is set for dial-up Internet access, it is not required to set ADSL dial-up account and password on the IP Camera end. The structure of network connection is the same as that in the LAN.

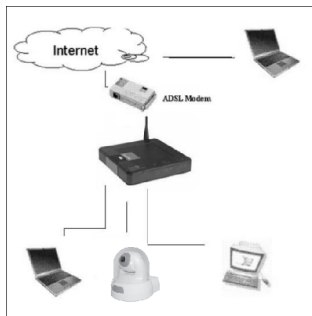

If the IP Camera is set for dial-up Internet access within a router or other IP sharer, it is required to set ADSL dial-up account and password on the IP Camera end (for details, refer to Setting ADSL Account and Password), and it is preferable to set the DDNS domain service at the same time (for details, refer to Setting DDNS). Click **<Apply>** and the IP Camera will reboot. After rebooting, reconnect the IP Camera according to the network structure shown in the above figure. Wait for several minutes and the IP Camera will dial up to access the Internet automatically, and the communication with the DDNS server is established successfully. In this way, the user can access

the IP Camera from a WAN by using the DDNS domain name.

(2)Connecting directly with ADSL Modem for Internet access Set ADSL dial-up account and password (for details, refer to Setting ADSL Account and Password), and it is preferable to set the DDNS domain name at the same time (for details, refer to Setting DDNS). Click <**Apply**> and the IP Camera will reboot. After rebooting, disconnect the power supply and network cable of the IP Camera and then reconnect them according to the network structure shown in the above figure. Wait for several minutes and the IP Camera will dial up to access the Internet automatically, and the communication with the DDNS server is established successfully at the same time. In this way, the user can access the IP Camera on the Internet by using the DDNS domain name

### 3. Accessing the IP Camera from the Internet

For each ADSL reconnection, ISP will re-assign a new IP address for the IP Camera to facilitate the access. The user can also enable DDNS service at the same time. For detailed settings, refer to DDNS settings described in the aforesaid Section 7-1-5-2 Upon completion of setting, we can access the IP Camera through a registered fixed domain name address.

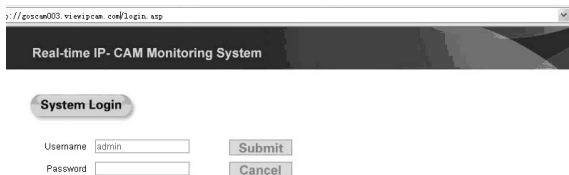

#### 7-1-5-4 Setting wireless functions of IP Camera

When the IP Camera does not support wireless functions, Wi-Fi parameters are unavailable. When the IP Camera supports wireless functions, Wi-Fi parameters become available, including IP address, subnet mask, gateway, SSID, and so on.

WiFi Parameters	
Enable WiFi	<input type="checkbox"/>
IP address	192.168.1.2
Subnet mask	255.255.255.0
GateWay	192.168.1.1
SSID	111111
Password	*****
Frequency band	Auto
Mode	Auto

Example: http://goscam003.3322	
PPPOE Parameters	
Enable PPPOE	<input type="checkbox"/>
PPPOE URL	
PPPOE username	
PPPOE password	
Online time	0x120x05

To use the wireless functions of the IP Camera, a wireless router like linksys is required.

Enter the linksys wireless router and click **Setup**, as shown in the figure below. Where, the user can set the IP address of the wireless router, for example, 192.168.1.254. The IP address is also the gateway address in setting the wireless functions of the IP Camera.

Setup	
Setup	Wireless
Back Setup	DDNS
MAC Address Clone	Advanced Routing
Network Setup	
Router IP	Local IP Address: 192.168.1.254
	Subnet Mask: 255.255.255.0
	Local IP Address: This is the address of the router.
	Subnet Mask: This is the subnet mask of the router.

Click the **Wireless** tab and set the parameters as shown in the figure below:

Wireless	
Setup	Wireless
Basic Wireless Settings	Wireless Security
Wireless MAC Filter	Advanced Wireless Settings
Wireless Network	
Wireless Network Mode:	Fixed
Wireless Network Name (SSID):	111111
Wireless Channel:	6 - 2.437GHz
Wireless SSID Broadcast:	<input checked="" type="radio"/> Enable <input type="radio"/> Disable
 Status: SES Inactive <input type="button" value="Reset Security"/>	
Wireless Network Mode: If you wish to exclude Wireless-G clients, choose B-Only Mode. If you would like to disable wireless access, choose Disable. More...	
<input type="button" value="Save Settings"/> <input type="button" value="Cancel Changes"/>	

[**Wireless Network Mode**]: Select **Mixed**.

[**Wireless Network Name**]: Enter the SSID of the wireless network, for example, **111111**.

[**Wireless Channel**]: Select any one of wireless channels, for example, **6-2.437GHZ**.

[**Wireless SSID Broadcast**]: Select the **Enable** option button. Upon completion of setting, click <Save Settings>. The setting of wireless parameters for the wireless router is completed.

Enter the wireless function setting interface of the IP Camera. Select the **Enable Wi-Fi** check box.

[**Gateway**]: Enter the IP address of the wireless router, for example, 192.168.1.254.

[**Subnet mask**]: Enter subnet mask, for example, 255.255.255.0.

[**IP Address**]: Enter the IP address to access, for example, 192.168.1.2 (the IP address must be in the same network section as the gateway address, for example, it cannot be set to 192.168.2.2).

[**SSID**]: Enter the wireless network name set in the wireless router, for example, 111111.

Up till now, the setting of wireless functions of the IP Camera is completed. Disconnect the network cable of the IP Camera and access the camera through the wireless IP address 192.168.1.2, as shown in the figure below:

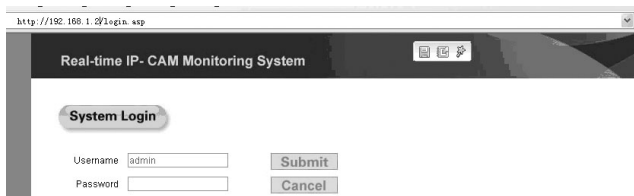

## 7-1-6 User Manage **Setting User Management Parameters of IP Camera**

The interface for setting the **User Manage** parameters of the IP Camera is as follows:

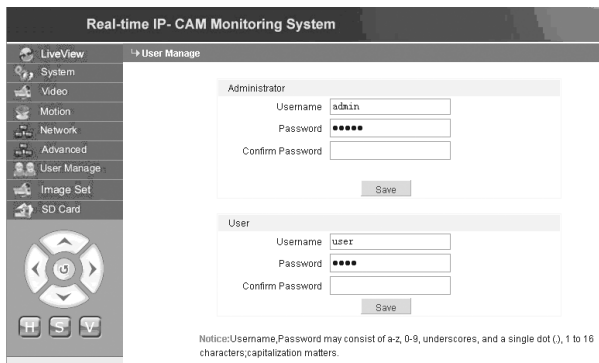

Real-time IP- CAM Monitoring System

LiveView → User Manage

System  
Video  
Motion  
Network  
Advanced  
User Manage  
Image Set  
SD Card

Administrator

Username

Password

Confirm Password

Save

User

Username

Password

Confirm Password

Save

Notice:Username,Password may consist of a-z, 0-9, underscores, and a single dot (.), 1 to 16 characters;capitalization matters.

Each IP Camera can be configured with two users: one is an administrator, and the other is a common user.

**Note:** The administrator can set the parameters of the IP Camera, while the common user does not have the right to make such settings.

**Default username of administrator: admin Password:admin**  
**Default username of common user 1: user1 Password:1**

## 7-2 Image Set **Image Settings of IP Camera**

 Adjust brightness. Click the brightness “+” icon continuously to increase the image brightness and click brightness “-” continuously to decrease the image brightness.

 Adjust contrast. Click the contrast “+” icon continuously to increase the image contrast and click contrast “-” continuously to decrease the image contrast.

**Click STD to set these parameters to default values.**

## 7-3 SD Card **SD Card Status Information of IP Camera**

 LiveView	↳ SD card information	
 System	SD Card Information	
 Video	TotalSize(M)	FreeSize(M)
 Motion	29	27
 Network		
 Advanced		
 User Manage		
 Image Set		
 SD Card		

**[SD Card]**: It does not require any user setting, but only displays the current status of the SD card, that is, total size and free size of the SD card.

## 7-4 LiveView Image Display Area of IP Camera



Click **<Snap>** to save the current image to a designated directory as a file, as shown in the figure below:





Click <**Record**> to start or stop recording. During recording, the color of the icon will change to green. If you click other option or setting at this time, the recording stops, as shown below:

#### Turn green during recording



Click <**Replay**>, and the recording playback control interface appears, as shown below:



**Note:** The recording files can be saved in the PC or the SD card. Please select PC or SD respectively and click <Search> to automatically search the saved images and recording files in a set time range. The searched files will be displayed in the File List column, as shown in the above figure.

**Operation method:** Double click the image/recording file to be viewed, or press “  ” to play.



Call <**Alarm**> to clear all IP Camera alarms temporarily.

## 8. Appendixes

### 8-1 FAQ

#### ★ Forgetting password

**Solution:** Press <RESET> in the rear panel of the IP Camera to restore all parameters to their default values.

**Note:** Those who are not service-trained professionals shall not press the <**RESET**> key. After resetting, all parameters will be recovered to their default values (excluding the physical address of the network).

#### ★ Abnormal upgrading or failure to reboot the IP Camera due to abnormal power failure during upgrading

**Solution:** Press and hold <RESET> in the rear panel of the IP Camera and then connect the power of the IP Camera. Release the button in about 12 seconds and the system will run the backup program. The backup program only provides upgrading and parameter setting functions, and does not support video and audio functions. In this status, the user can re-upgrade the system programs. The system will resume normal upon completion of upgrading.

#### ★ No plug-in display in IE

**Possible cause:** No plug-in is installed?

**Solution:** If it is the first time to use the IE (Internet Explorer) to access the IP Camera, plug-ins shall be installed.

Two installation methods are available:

### **a. Automatic installation**

You must reduce the IE security setting level temporarily so that the ActiveX components can be installed in your PC as follows:

- \* Select **Internet Options** from the Tools bar;
- \* Click the **Security** tab and pay attention to your current security settings;
- \* Set the **Security Level** to **Low**, and click **<Apply>**;
- \* Enter the IP Camera address in the address bar of the IE (such as: hhdemo1.vicp.Net) or click the demonstration link to open the IE window. If an alert box appears to ask you whether you want to install ActiveX, click **<Yes>** to start installation;
- \* Once the installation of the ActiveX is completed, recover the security settings to the default value.

### **b. Download and installation**

First download the control compression package from the IP Camera, extract it to a temporary directory, close all IE pages, and finally double click to extract the install.bat file under the directory and start installation. After completion of the installation, the system will prompt you that it is installed successfully.

### **★Why an error occurs when accessing the IP Camera via the IE after upgrade?**

**Solution:** Delete the cache of the IE.

**Operation procedures:** Select the **<Tools>** menu of the IE, and select **<Internet Options>**. Click **<Delete Files>** in the second entry (Internet Temporary Files), select **Delete All Offline Content** check box and then click **<OK>**. Log on to the IP Camera again.

### **★ Video failure after program upgrade**

**Solution:** Close all browse pages, find files “HHNetClient.dll” and “XDView.ocx” under the system directory C:\, and delete them. Then, use the IE to reconnect the IP Camera, and the IP Camera will automatically update play plug-ins.

## ★ Failure in accessing IP Camera via IE

**Possible cause 1:** Network interruption?

**Solution:** Use a PC to access the network to test whether the network access is normal. First remove cable fault, network fault caused by viruses until mutual successful pinging between the IP Camera and PC.

**Possible cause 2:** IP address occupied by other device?

**Solution:** Disconnect the connection between the IP Camera and the network, independently connect the IP Camera to the PC, and reset the IP address according to proper recommendations.

**Possible cause 3:** IP address in a different subnet?

**Solution:** Check the settings of IP address and subnet mask address of the Server, as well as the gateway settings.

**Possible cause 4:** Any conflict between the physical address over the network and the IP Camera?

**Solution:** Change the physical address of the IP Camera.

**Possible cause 5:** Web port changed?

**Solution:** Contact the administrator to obtain related port information.

**Possible cause 6:** Unknown?

**Solution:** Press the <**RESET**> key in the rear panel of the Server to restore the default settings, and then make reconnection. By default, the IP address is 192.168.55.160, and the subnet mask is 255.255.255.0.

## ★ Abnormal image display color (green or other colors)

**Solution:** Due to the difference of graphic card, sometimes, the images of the IP

## ★ Why normal data cannot pass a switch

### Possible cause:

1. For an L2 switch, possibly a wrong address is written.
2. For an L3 switch, check whether the port is bound with the physical address.
3. Is the Server considered when the firewall rules are configured? Before locating the network fault, please use the Ping command to connect the peer address in the command line mode. Checking the returned information after the pinging process is an important step. If the ping fails, it indicates that a fault occurs to the network. If the IP and MAC addresses are bound, it is necessary to make such settings inside the switch. Add a new binding, that is, the binding of the IP address of the IP Camera with the MAC address. If the Server is not considered when configuring the firewall rules for the switch, please refer to the port number used by the IP Camera, and reconfigure the switch.

## ★ How to use the IP Camera to transmit audio & video data over the Internet?

For the IP Camera to transmit audio & video data over the Internet, first know you own network access mode: For static IP address of the Internet, directly set the IP address, subnet mask and gateway of the Server to the static address provided by the ISP, and you will be able to browse normally. In addition, the currently two widest applied access modes, ADSL and community broadband network need the authentication process. The authentication can be completed by some intelligent devices such as PCs or small routers. Inside the LAN, there is no IP address of the Internet, so an Extranet cannot access the LAN. In this case, some settings shall be made in the access server.

### Solution:

1. In applications in a LAN in offices or buildings, if you want to access the IP Camera from other cities, you may use the IP Camera accessing to the Internet to make forwarding. Use port mapping to forward information packets. Use some current popular port mapping software to make simple settings, for example, Portmap and portunnel. Select all IP addresses among the access IP

addresses, and then fill in the address of the IP Camera inside the LAN.

2. It is also a good solution to select a router as the forwarding device if no PC is available. Presently most routers provide port mapping function (DMZ). Directly designate the DMZ address as the address of the IP Camera.

## 8-2 Network Ports Occupied by IP Camera

**By default, the IP Camera occupies the following network ports**

---

TCP	80 (Web port)	5000 (communication port, audio & video data transmission port, call data transmission port)
UDP	5000 (audio & video data transmission port)	
Multicast port	Multicast start port + channel Number	

---

**Note:** Please pay attention to the port No. occupied by the IP Camera upon port mapping configuration

## 8-3 Default Parameters

### Default network parameters:

IP address:192.168.1.1

Subnet mask:255.255.255.0

Gateway:192.168.1.254

COM port:5000

Web port: 80

DHCP:Disabled

DDNS:Disabled

### Username and password

Default administrator username: **admin**

Password: **admin**

Default username for common user 1: **user1**

Password: **1**

## **FCC information**

This device complies with part15 of the FCC Rules. Operation is subject to the following two conditions:

- (1) this device may not cause harmful interference,
- (2) this device must accept any interference received, including interference that may cause undesired operation.

Changes or modifications not expressly approved by the party responsible for compliance could void the user' s authority to operate the equipment.

## **CAUTIONS**

- The apparatus shall not be exposed to dripping or splashing and that no objects filled with liquids, such as vases, shall be placed on the apparatus.
- Turn off the Camera/Receiver if the system is not in use.
- The adapter is used as the disconnect device from the mains. The adapter shall remain readily operable.
- The Camera/Receiver can only be completely disconnected from the mains by unplugging the adapter.
- Do not cut the DC power cable of the apparatus to fit with another power source.
- Attention should be drawn to the environment aspects of battery disposal.

### **EU Environmental Protection**

Waste electrical products should not be disposed of with household waste. Please recycle where facilities exist. Check with your Local Authority or retailer for recycling advice.



